

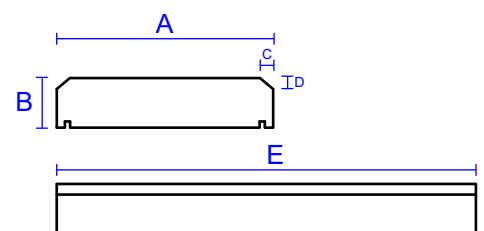

COPINGS

* all dimensions in (mm)

All copings types are available as :
Random Length 500 - 1000mm
Internal/External Corners, Square or Elbow.
Stop Ends
Single or Twice Throated upon request
Bespoke sizes, profiles & dressing upon request.

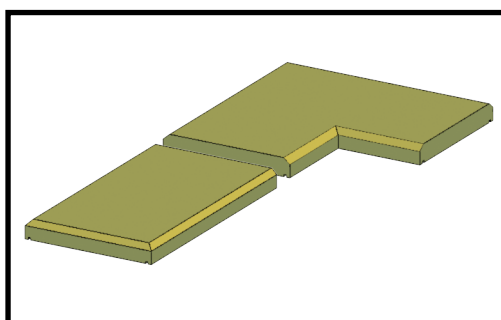
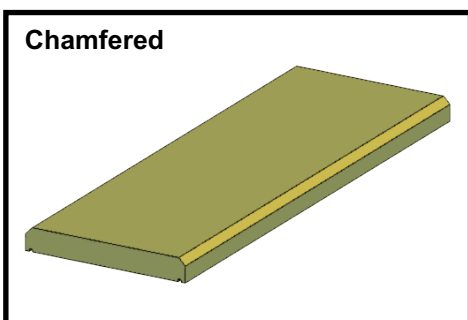
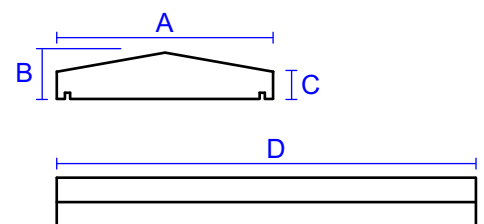
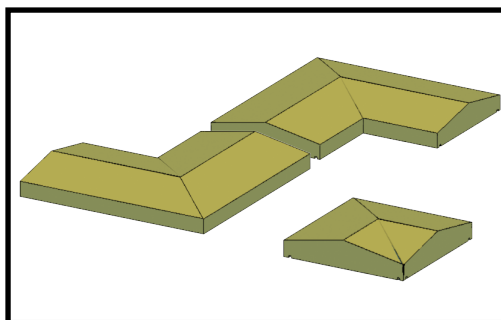
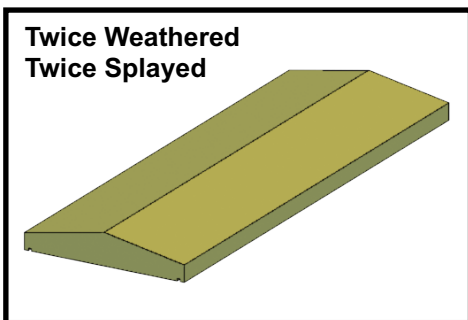
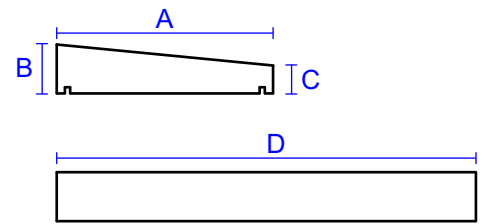
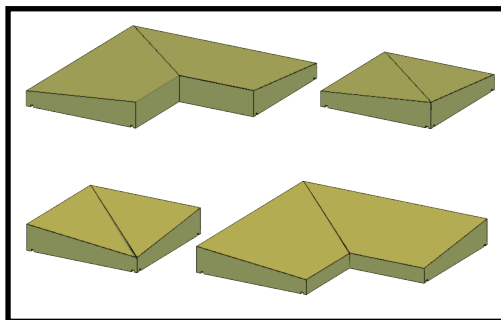
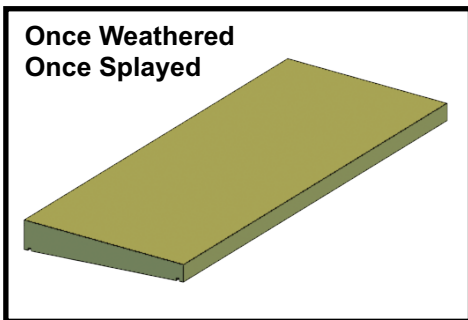
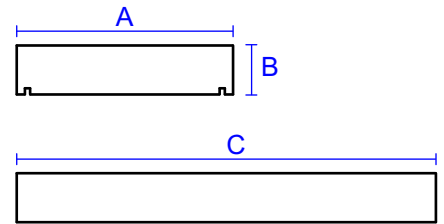
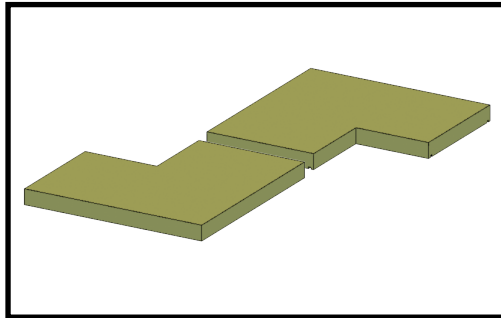
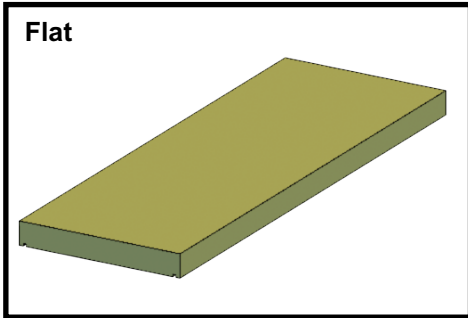

Once / Twice Chamfered



COPINGS

* all dimensions in (mm)

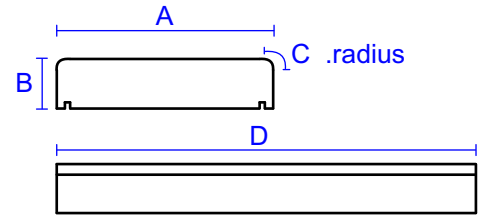
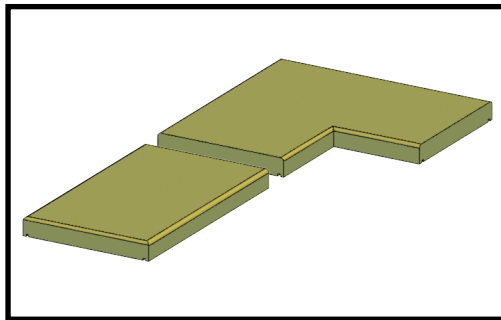
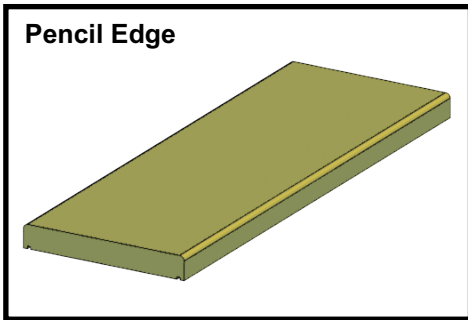

Once / Twice Pencil Edged

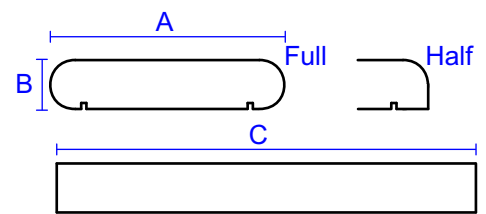
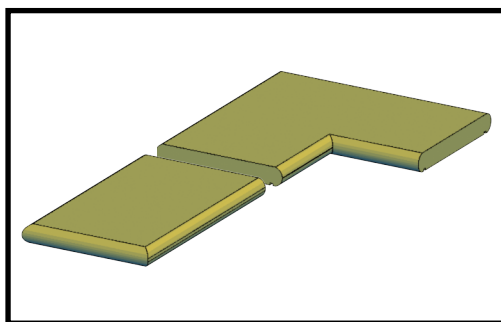
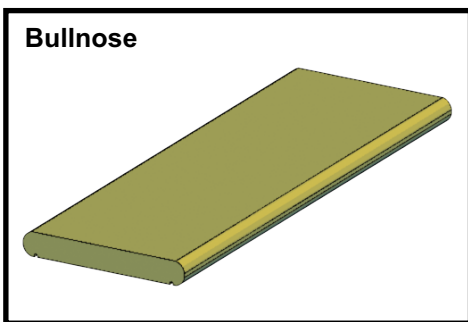

Once / Twice Bullnose
Half / Full Bullnose - 30,40,50mm

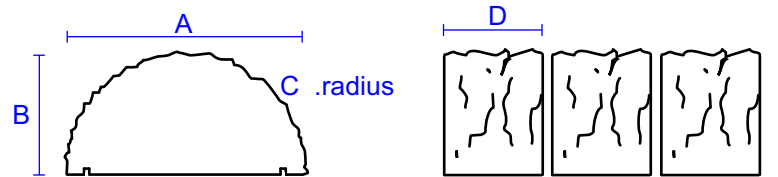
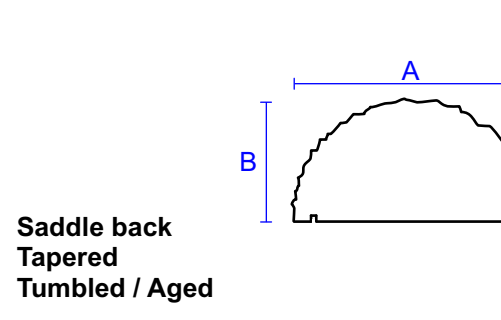
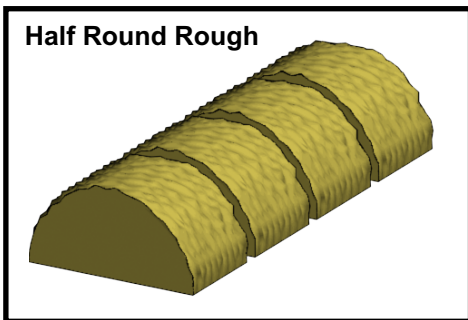
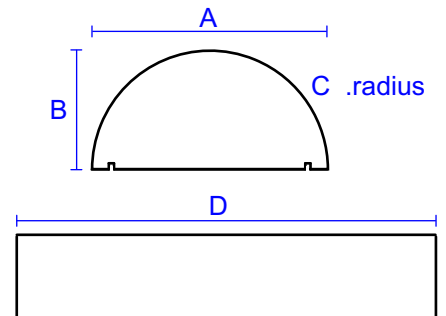
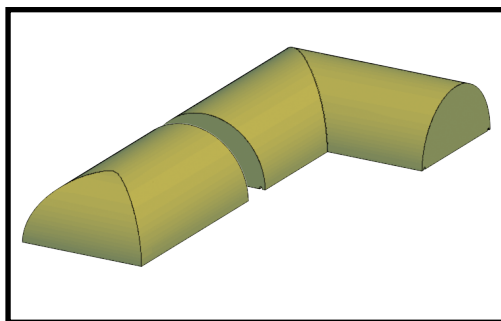
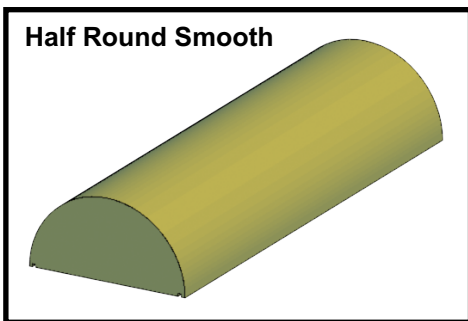

Saddle back
Tapered
Tumbled / Aged

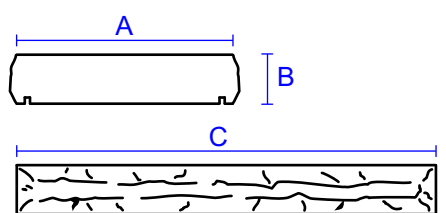
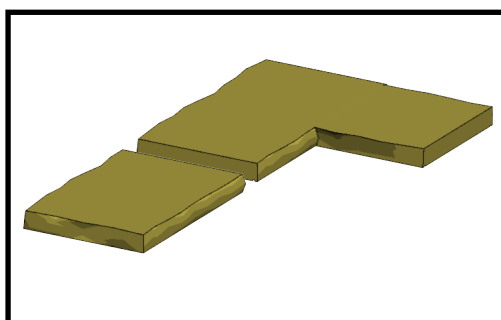
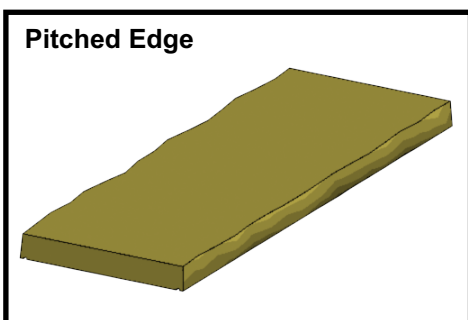

Once / Twice Bullnose
Half / Full Bullnose - 30,40,50mm



COPINGS

* all dimensions in (mm)

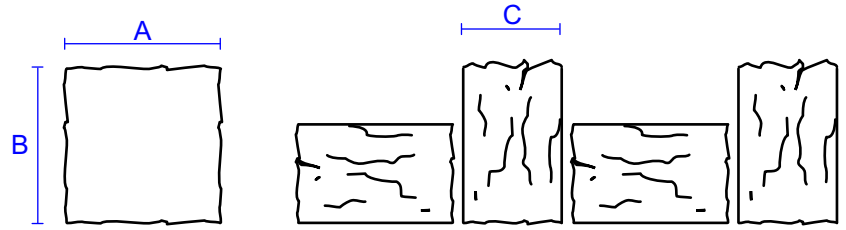
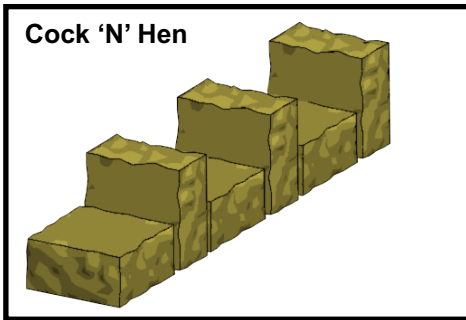

Tumbled / Aged

PIER CAPS

* all dimensions in (mm)

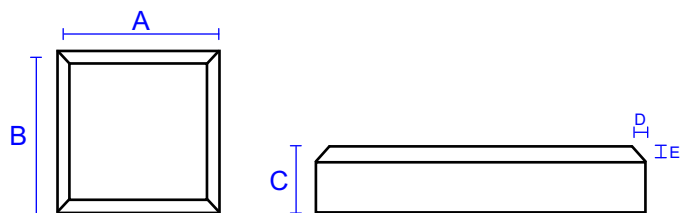
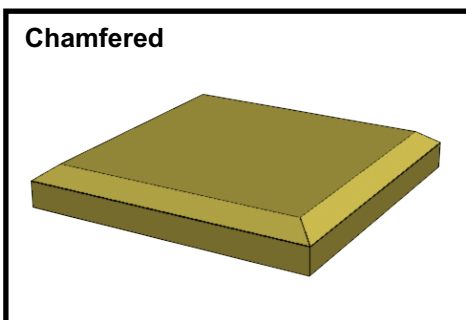
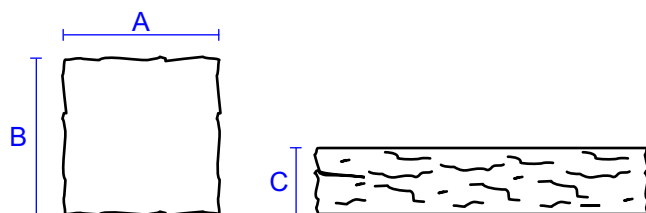
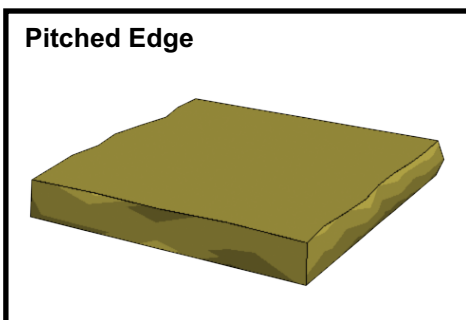
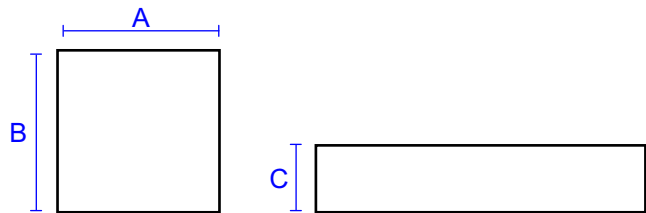
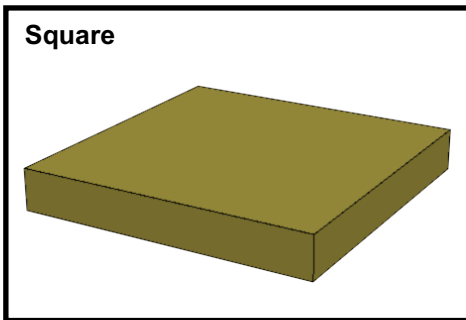



PIER CAPS

* all dimensions in (mm)

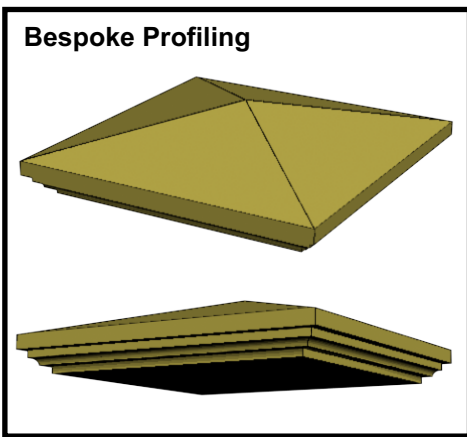
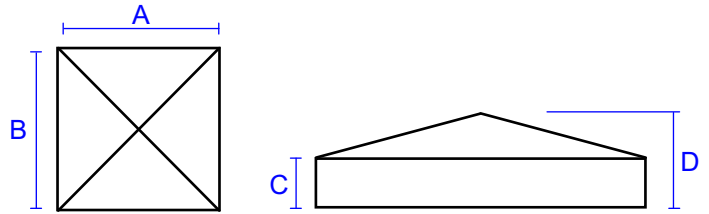
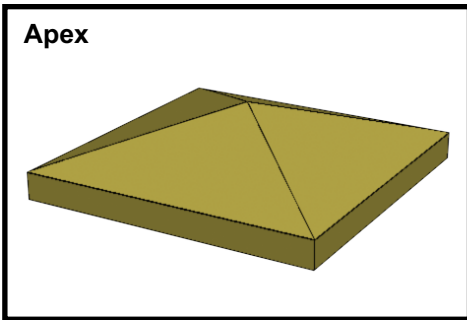

Bespoke designs and sizes

